



Skin @ School

Worksheets for children aged 6-8 years

Name:

Developed by Huid Nederland (Dutch Skin Coalition) in collaboration with dermatologists (NVDV), specialized nurses, skin therapists (NVH), representatives of patient associations, teachers, a school principal, and a didactic specialist.
© Dutch Skin Coalition, 2024.

LESSON 1

What does the skin look like?

This puzzle is about the story of Luke and the tiger.
Write down the correct words. Some letters are already filled in.

1	animal that sheds
2	animal that cannot sweat
3	boy with dry skin
4	animal with stripes on the skin
5	animal with poisonous skin

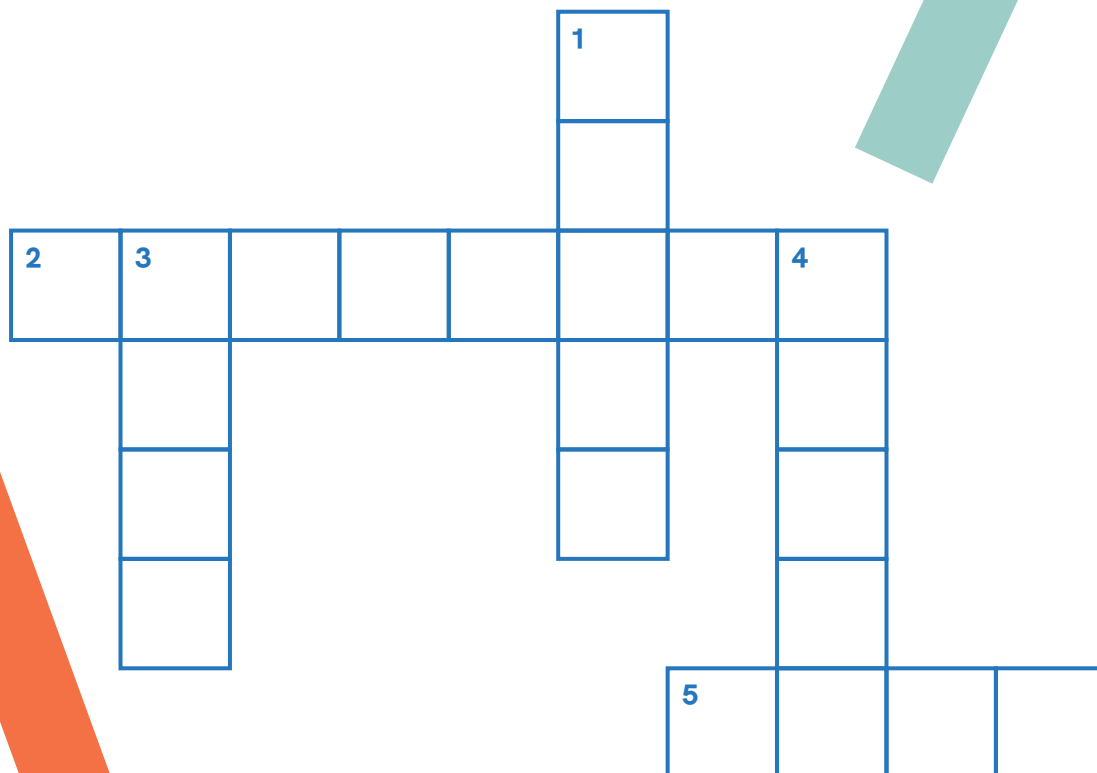

LESSON 2

Caring for the skin

1. How does your skin get clean? Choose the two correct pictures and color them.

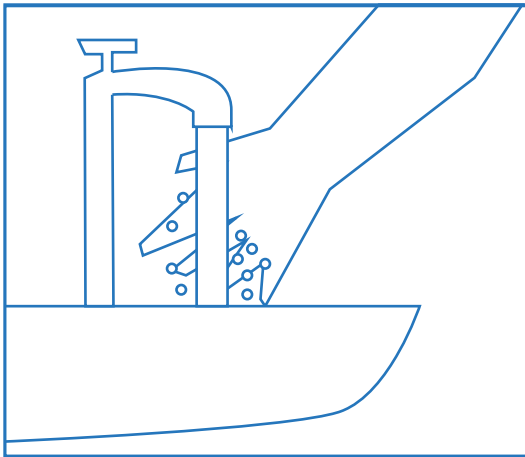

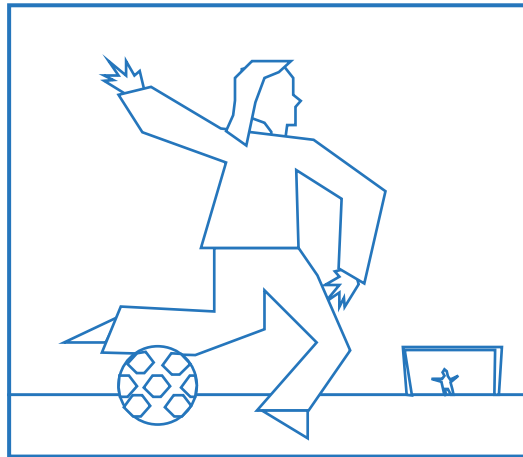

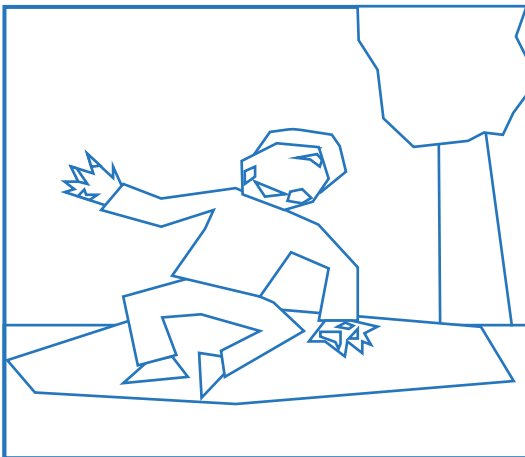

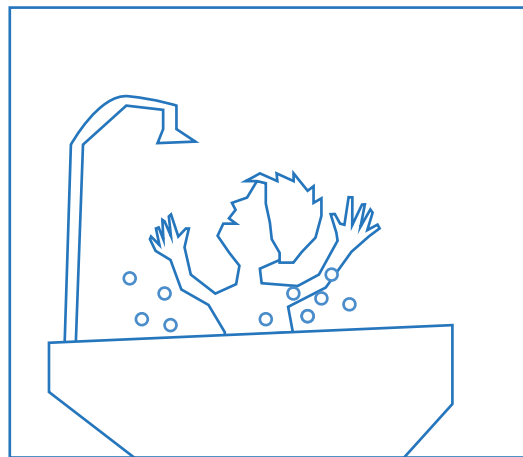

2. Write these four words under the correct drawings above.

bath

faucet

mud

playing soccer

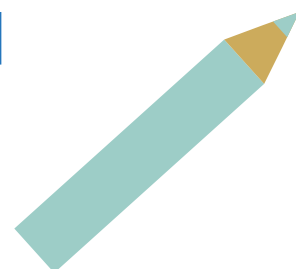

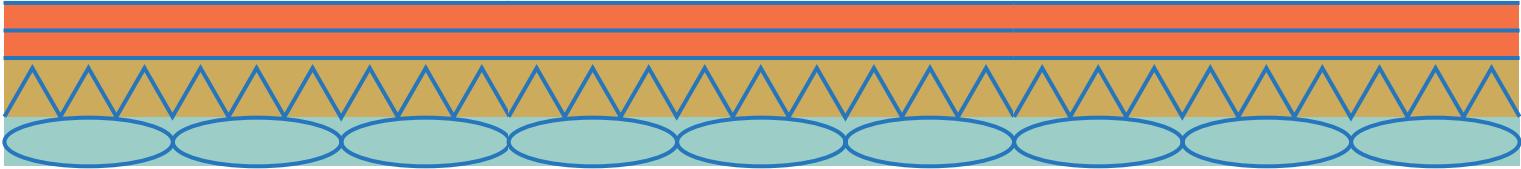

3. What happens first? Put a 1 there. Then also fill in 2, 3, and 4.

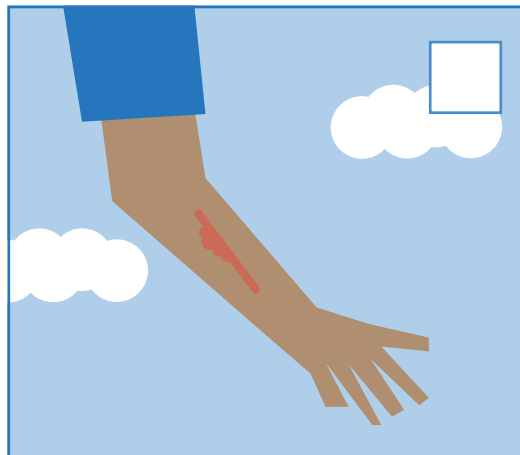
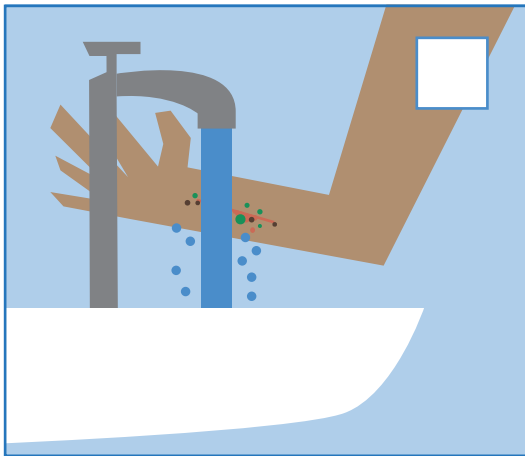

4. Circle a band-aid that best matches your skin color.

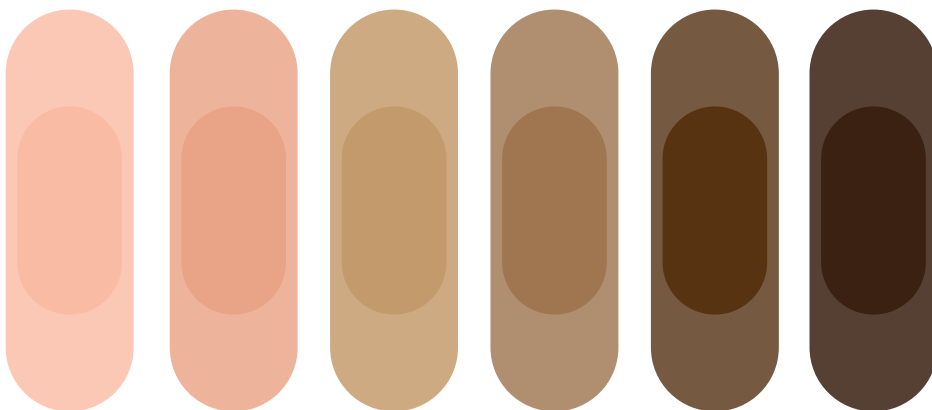

5. Find the ten words in the word search. Cross them out.

bacteria	infection
bath	band-aid
healthy	fat
skin-color	wound
faucet	soap



q	i	n	f	e	c	t	i	o	n	w
f	a	u	c	e	t	y	w	r	s	e
t	s	k	i	n	-	c	o	l	o	r
u	i	o	p	a	s	d	u	f	a	g
h	f	j	k	l	b	z	n	x	p	c
b	a	n	d	-	a	i	d	n	b	v
c	t	b	a	c	t	e	r	i	a	w
h	e	a	l	t	h	y	c	v	b	m

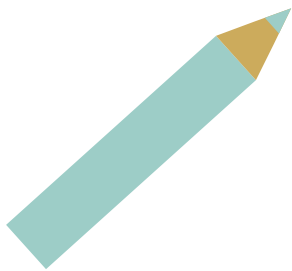

LESSON 3

Temporary Skin Problems

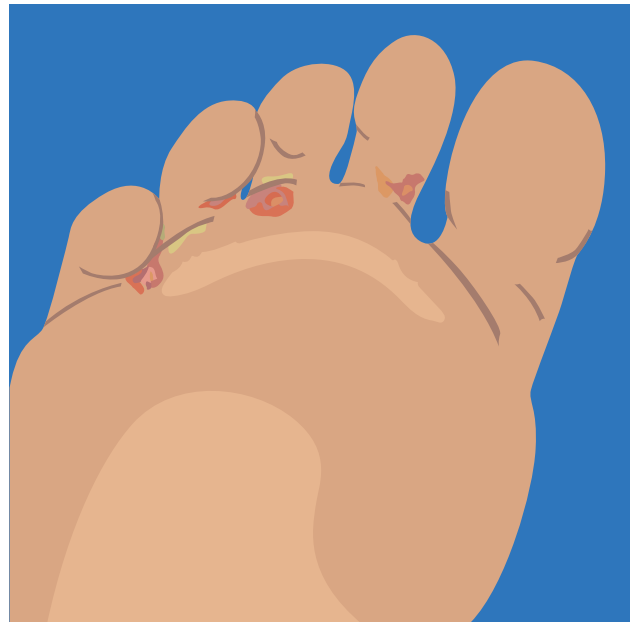

LESSON 4

Protect your Skin from the Sun

Look at the eight pictures and eight words.

1. Write the words under the correct pictures.
2. Which (four) things can you use to protect yourself from sunburn?
3. Circle those (four) things.



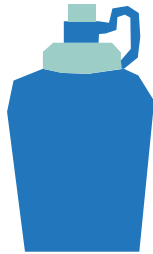



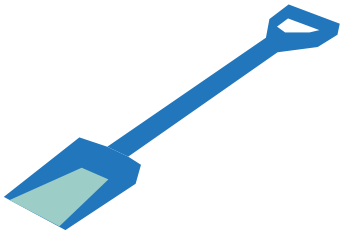





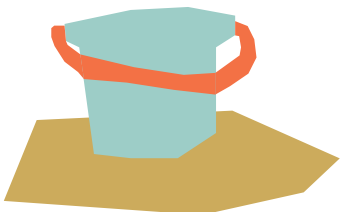



- Glasses
- Bucket
- Bottle
- Hat
- Parasol
- Shovel
- Shoes
- Shirt

LESSON 5

Long term skin problems

1 Circle the correct words.



a This condition is called:
measles / mosquito bite /
giant birthmark

This condition is
contagious / not contagious

This condition lasts
short time / a while / very long



b This condition is called:
measles / mosquito bite /
giant birthmark

This condition is
contagious / not contagious

This condition lasts
short time / a while / very long

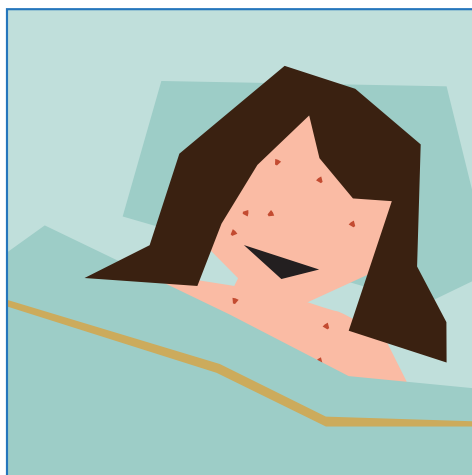

c This condition is called:
measles / mosquito bite /
giant birthmark

This condition is
contagious / not contagious

This condition lasts
short time / a while / very long

LESSON 5

Long-term skin problems

2 Circle the correct words.



a This condition is called:
eczema / psoriasis / vitiligo

This condition is
contagious / not contagious

This condition lasts
short time / a while / very long

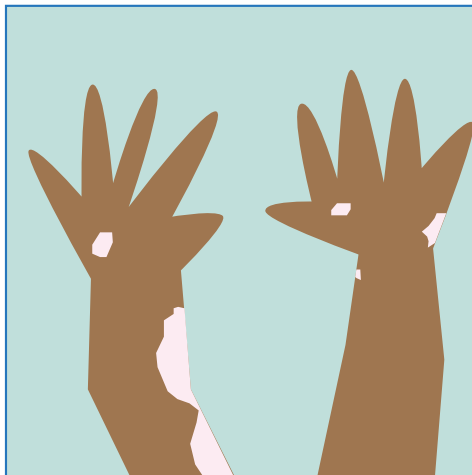

b This condition is called:
eczema / psoriasis / vitiligo

This condition is
contagious / not contagious

This condition lasts
short time / a while / very long



c This condition is called:
eczema / psoriasis / vitiligo

This condition is
contagious / not contagious

This condition lasts
short time / a while / very long